

RAIL PENDANT 6W

Installation Manual

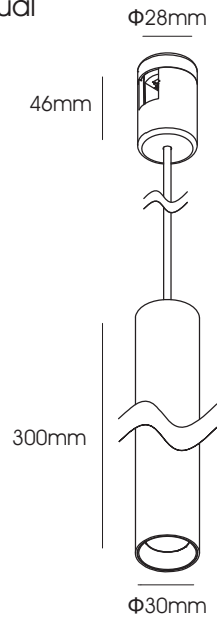

1



Attention
Switch off the main power.

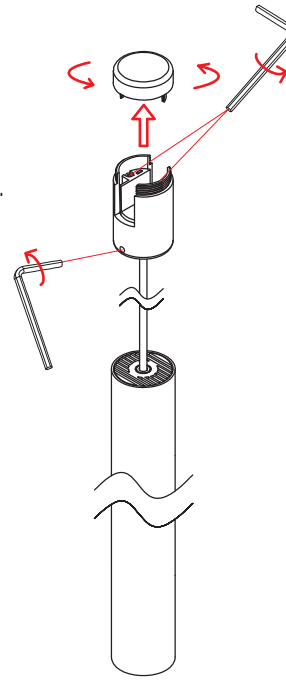
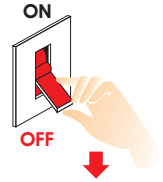

2

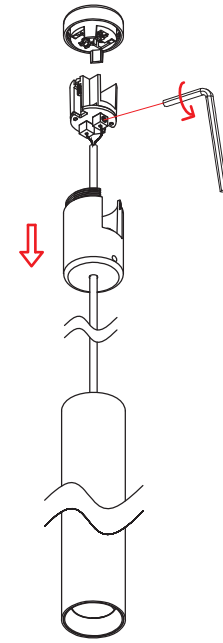

3

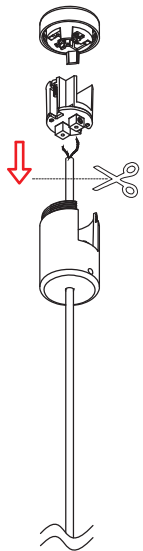

4

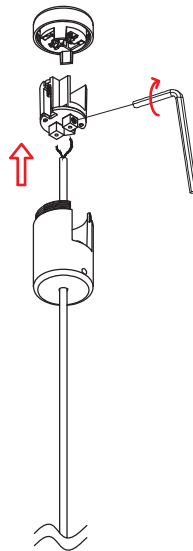

5

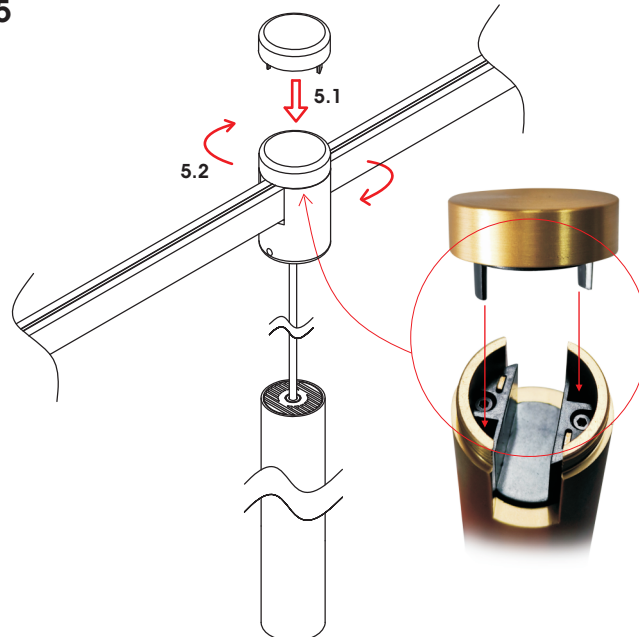

6

